

SV-45
SV-85

Duplo Glass

SV-45 / SV-85 son dos sistemas de puertas correderas de vidrio suspendidas, sin marco y de alta calidad. Ideales para armarios, divisiones y puertas de uso doméstico o comercial de peso ligero o medio. Destacan por su perfil doble, el cual alberga 2 puertas en el mínimo espacio.

CARACTERÍSTICAS

Aplicaciones para hojas de 45 y 85 Kg de peso respectivamente. Se componen de un perfil doble superior de aluminio natural con estrías laterales que permiten, si se desea, fijar y extraer las tapetas con la finalidad de

ocultar dicho perfil y el resto del mecanismo. La doble perfilería proporciona una distancia mínima entre puertas de sólo 16 mm (para vidrios de 10 mm de espesor) y de 20 mm (para vidrios de 8 mm de espesor). Pinzas de alta calidad y roldanas con rodamiento a bolas para asegurar un funcionamiento suave y de deslizamiento silencioso. Regulación vertical de ± 2 mm y guiador inferior ajustable para permitir la instalación de vidrios de diferentes espesores (8-10 mm).

NO SE REQUIERE MECANIZACIÓN DEL VIDRIO.

Características técnicas

Pictogramas

Perfilería

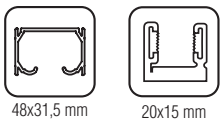

48x31,5 mm

20x15 mm

Especificaciones

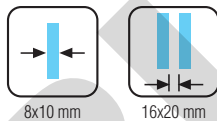

8x10 mm

16x20 mm

Pesos

45 kg

85 kg

Variantes de instalación



Sección tipo. SV - 45 / SV - 85

Montaje a pared

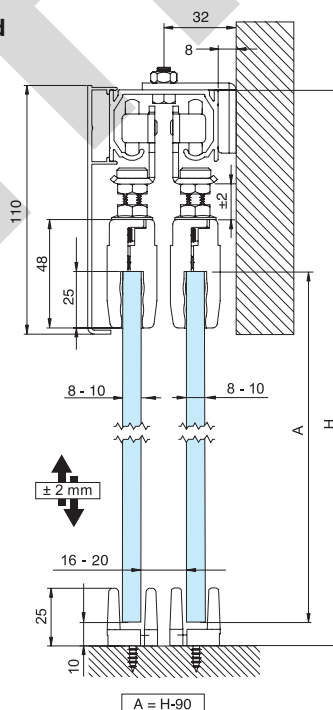

Cotas en mm

A = H - 90



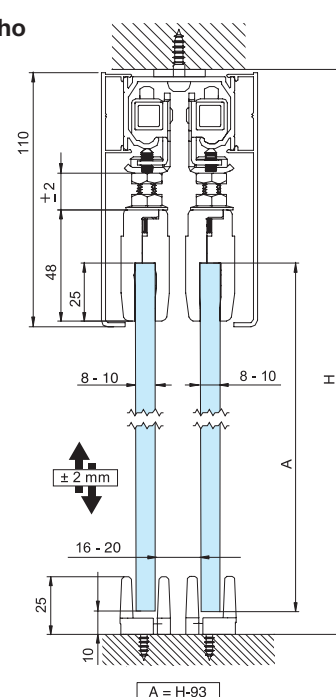



Montaje a techo

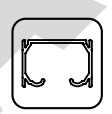
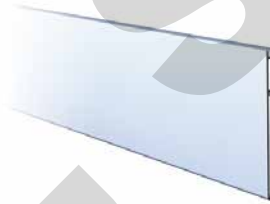
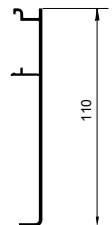

A = H - 93

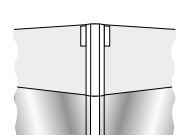

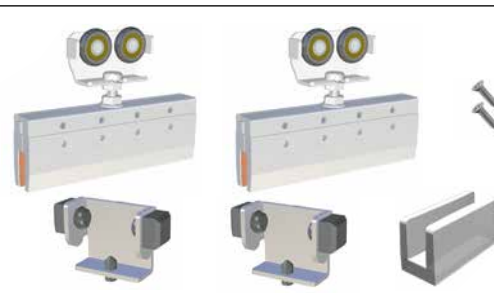



MECANISMOS PARA PUERTAS CORREDERAS **DUPLO GLASS SV-45 / SV-85**

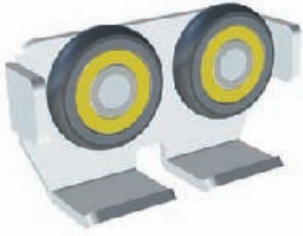

DESCRIPCIÓN	REFERENCIA	
PERFIL AÉREO DOBLE HOJA PARA 85 kg Acabado: Aluminio natural		85/20 85/30 85/50
Longitud: 2000 mm 3000 mm 5000 mm	2922.2 2922.3 2922.5	  48x31,5 mm
PERFIL TAPA		104/20 104/30 104/50 104/21 104/31 104/51 104/22 104/32 104/28 104/38
Acabado: Anodizado plata Longitud: 2000 mm 3000 mm 5000 mm	2927.2 PL 2927.3 PL 2927.5 PL	  110
Acabado: Lacado blanco Longitud: 2000 mm 3000 mm 5000 mm	2927.2 BL 2927.3 BL 2927.5 BL	
Acabado: Plata brillo Longitud: 2000 mm 3000 mm	2927.2 PB 2927.3 PB	
Acabado: Efecto inox mate Longitud: 2000 mm 3000 mm	2927.2 IN <i>Novedad</i> 2927.3 IN	
JUEGO ESQUINERAS PARA PERFIL TAPA Material: Pástico		103/02 103/03 103/04
Acabados: Plata Blanco Efecto inox mate	2930.6 PL 2930.6 BL 2930.6 IN	 
JUEGO COMPLETO DE ACCESORIOS PARA 45 kg Vidrio 8/10 mm	675.10	46/01 SV-1 CLASSIC   RODAMIENTO A BOLAS
JUEGO COMPLETO DE ACCESORIOS PARA 85 kg Vidrio 8/10 mm	675	96/00 SV-2 CLASSIC   RODAMIENTO A BOLAS

MECANISMOS PARA PUERTAS CORREDERAS

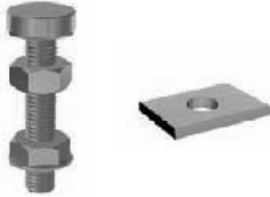
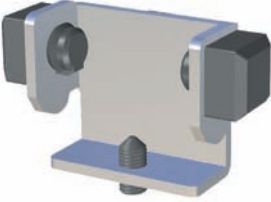
DUPLO GLASS SV-45 / SV-85

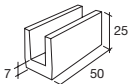
DESCRIPCIÓN	REFERENCIA		
ROLDANA SV-45/85 Para 85 kg	675.1		96/55  RODAMIENTO A BOLAS
PINZA REGULABLE Para 45 kg Vidrio 8/10 mm	660.2		40/58 SV-1 CLASSIC 
PINZA REGULABLE Para 85 kg Vidrio 8/10 mm	668.2		61/58 SV-2 CLASSIC 
TORNILLO REGULADOR	675.3		46/56
TOPE FRENO	675.4		96/57
GUÍA INFERIOR PLÁSTICO Vidrio 8/10/12 mm	660.3		40/57 

MECANISMOS PARA PUERTAS CORREDERAS DUPLO GLASS SV-45 / SV-85

DESCRIPCIÓN	REFERENCIA		
<p>GUÍA INFERIOR ALUMINIO Vidrio 8/10/12 mm</p> <p>Acabados: Anodizado plata Efecto inox mate</p>	<p>2877 PL 2877 IN</p>	 <p>Anodizado plata</p>  <p>Efecto inox mate</p> 	<p>42/57 42/58</p>
<p>SOPORTE LATERAL REGULABLE Y REVERSIBLE</p>	676	 	96/58
<p>SEPARADOR COMPENSADOR DE ALUMINIO</p>	2916.1	 	60/61
<p>SOPORTE PARA TAPA DE MADERA</p>	664		66/59
<p>PERFIL INFERIOR ALUMINIO CON CEPILLO Vidrio 8/10/12 mm</p> <p>Acabado: Anodizado plata</p> <p>Longitud: 2000 mm 3000 mm 6000 mm</p>	<p>2939.2 PL 2939.3 PL 2939.6 PL</p>	  <p>20x15 mm</p>	<p>41/22 41/32 41/62</p>